

YEARS: 2017-PRESENT

MAKE: VOLVO

MODEL: S90

STYLE: SEDAN

**WARNING: NEVER EXCEED YOUR VEHICLE MANUFACTURER'S RECOMMENDED TOWING CAPACITY**  
 For more information log onto [www.curtmfg.com](http://www.curtmfg.com) & for helpful towing tips log onto [www.hitchinfo.com](http://www.hitchinfo.com)

**WEIGHT CARRYING:**  
 TRAILER WEIGHT: 5,000 LBS.  
 TONGUE WEIGHT: 500 LBS.

**WARNING:**  
 WE RECOMMEND THE USE OF 18050 STABILIZING STRAPS FOR ALL NON-TRAILER (WHEEL-LESS) LOADS. PLEASE SEE THE CURT CATALOG OR VISIT US ONLINE AT [WWW.CURTMFG.COM](http://WWW.CURTMFG.COM) FOR FURTHER INFORMATION.

**PRO INSTALL TIME: 60 MIN.**  
**NOVICE INSTALL TIME: 120 MIN.**

IF YOU ARE HESITANT TO UNDERTAKE THIS TASK ON YOUR OWN, CONTACT AN AUTHORIZED CURT INSTALLER FOR ADDITIONAL ASSISTANCE.

**INSTALLATION TIPS:**

- BEFORE YOU BEGIN INSTALLATION, READ ALL INSTRUCTIONS THOROUGHLY.
- TO EASE INSTALLATION, 2 PEOPLE MAY BE REQUIRED.
- USING PROPER TOOLS WILL GREATLY IMPROVE THE QUALITY OF THE INSTALL AND REDUCE THE TIME REQUIRED.
- NEED HELP OR HAVE SOME QUESTIONS? CALL TECHNICAL SUPPORT AT 800.798.0813



**INSTALLATION REQUIRES:**

<b>TORQUE WRENCH</b>	<b>RATCHET</b>	<b>8" SOCKET EXTENSION</b>
<b>8mm 10mm 15mm SOCKET</b>	<b>TORXBIT T-25 SOCKET</b>	<b>CRESCENT WRENCH</b>
<b>PRY BAR</b>	<b>AVIATION SHEARS</b>	<b>SAFETY GLASSES</b>

**LEVEL OF DIFFICULTY: MODERATE**

EASY	MODERATE	CHALLENGING
PART REMOVAL	TEMPORARILY REMOVE TRUNK CONTENTS AND REAR FASCIA	
NO DRILLING REQUIRED	NO DRILLING REQUIRED	
TRIM	REAR FASCIA TRIMMING REQUIRED	

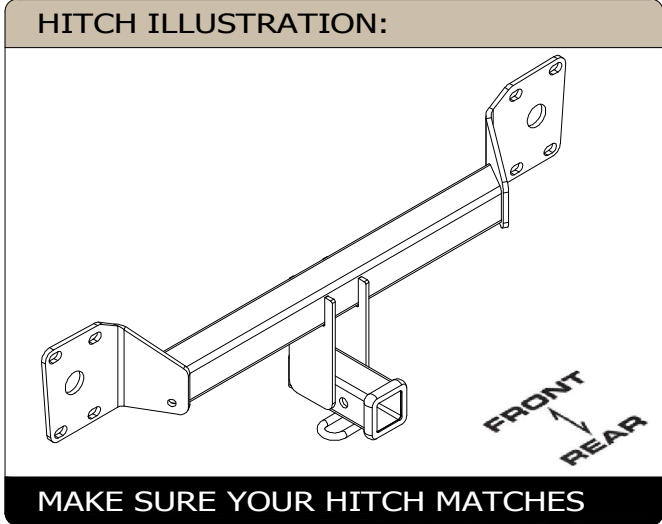

**PERIODICALLY CHECK THIS RECEIVER HITCH TO ENSURE ALL FASTENERS ARE TIGHT AND ALL STRUCTURAL COMPONENTS ARE SOUND**  
 CURT Manufacturing LLC. warrants this product to be free of defects in material and/or workmanship at the time of retail purchase by the original purchaser. If the product is found to be defective, CURT Manufacturing LLC. may repair or replace the product at their option, when the product is returned, prepaid, with proof of purchase. Alteration to, misuse of, or improper installation of this product voids the warranty. CURT Manufacturing LLC.'s liability is limited to repair or replacement of products found to be defective, and specifically excludes liability for incidental or consequential loss or damage.  
 For more information log onto [www.curtmfg.com](http://www.curtmfg.com) , & for helpful towing tips log onto [www.hitchinfo.com](http://www.hitchinfo.com)  
 This product complies with safety specifications and requirements for connecting devices and towing systems of the state of New York, V.E.S.C.Regulation V-5 and SAE J684.

## INSTALLATION WALKTHROUGH:

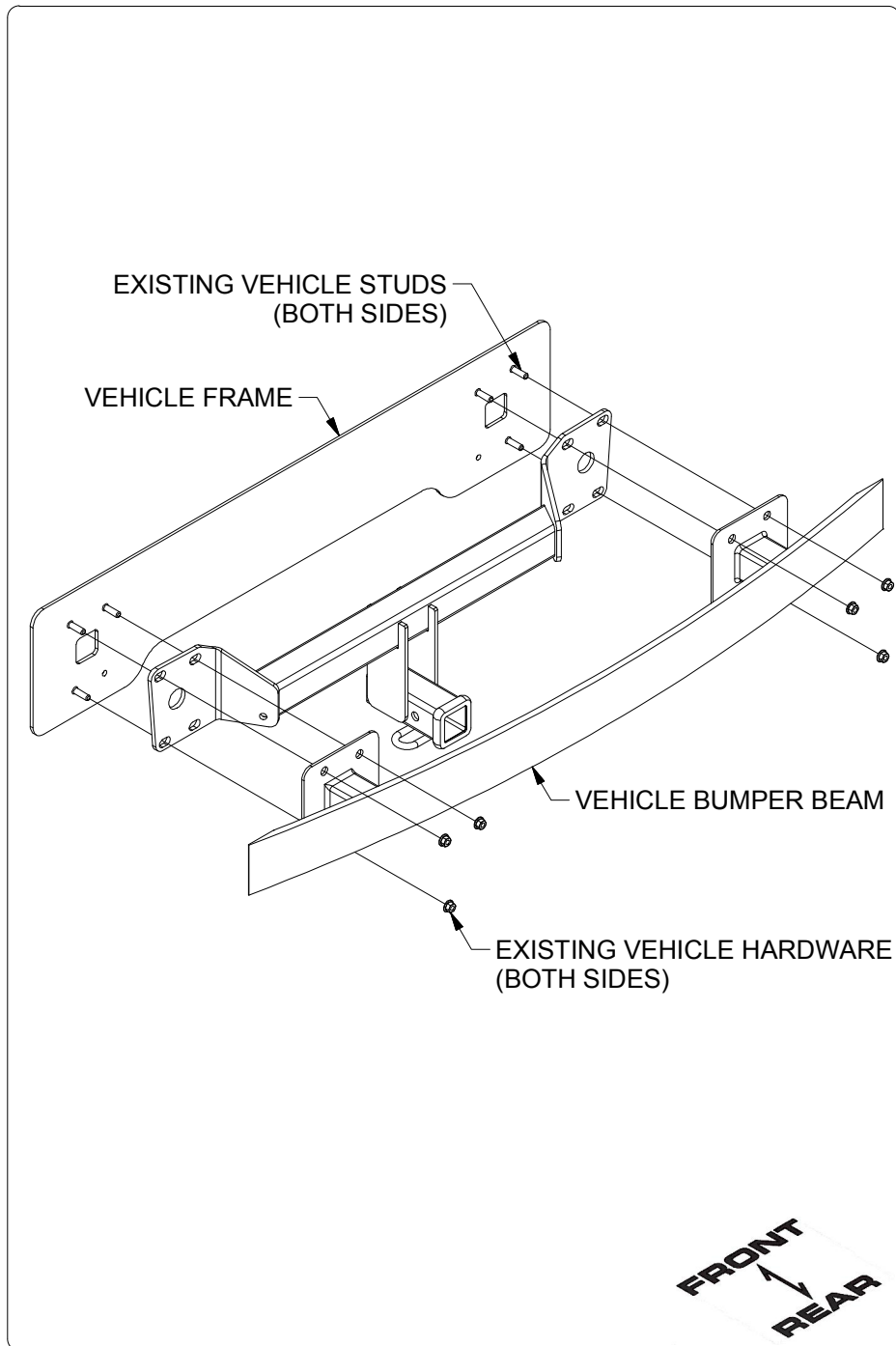

1. Underneath rear of vehicle, locate and remove (4) screws attaching rear fascia to vehicle using T-25 socket.

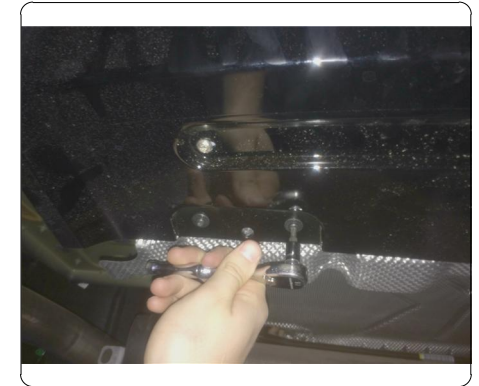
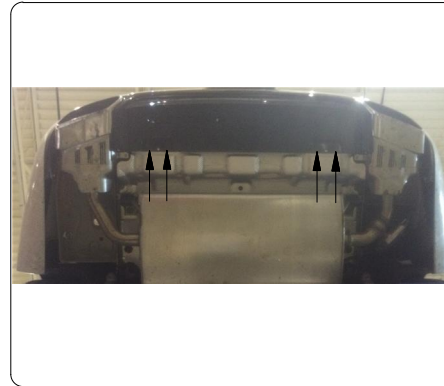

2. Along rear wheel well on each side, locate and remove (5) screws using T-25 socket.

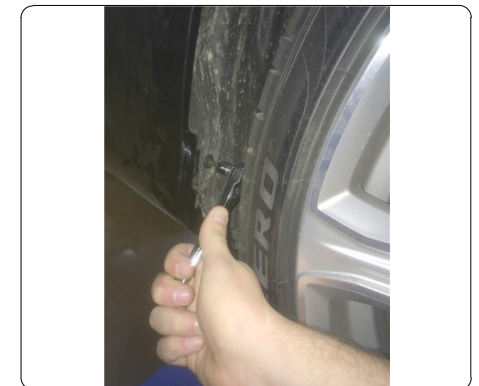
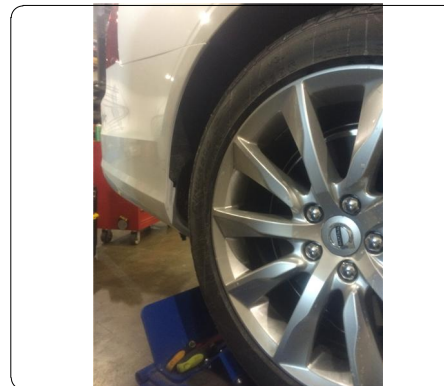

## INSTALLATION WALKTHROUGH:

3. Pull wheel well cover back on each side of vehicle to expose (1) screw remove using T-25 socket.  
**NOTE:** Remove plastic clip with screw behind wheel well cover.

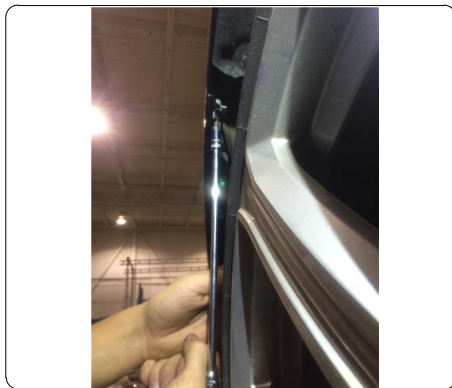

4. Inside trunk along trunk liner guard locate and remove (2) capped nuts using crescent wrench and (2) bolts using 10mm socket. Gently unclip trunk liner guard and set aside for reinstallation.

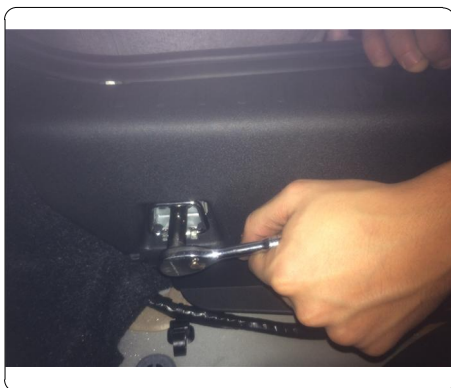

5. Remove trunk liner to expose (5) plastic nuts, remove plastic nuts using 10mm socket. Set aside for reinstallation.



6. On trunk wall gently unclip (1) plastic push pin, on each side, to expose (3) taillight nuts, on each side. Remove taillight nuts using 8mm socket and unclip electrical harness. Set aside hardware for reinstallation.

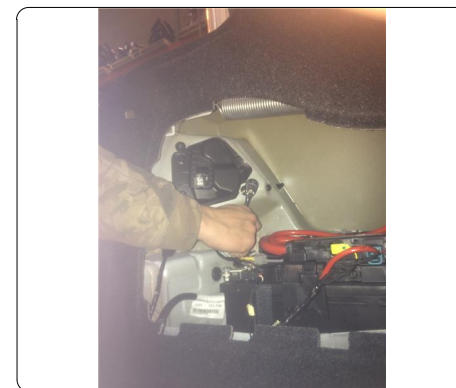



## INSTALLATION WALKTHROUGH:

7. Gently unclip rear fascia and remove starting from outside and working your way towards center of vehicle. Unclip electrical harness. Trim 3.25" x 5.00" section using aviation shears as shown in trim diagram. Set aside for reinstallation.  
**NOTE:** All dimensions are approximate, confirm fit prior to trim.

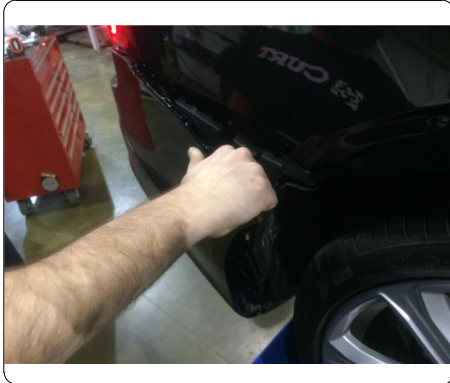

8. Locate on each side of bumper beam and remove (3) nuts using 15mm socket. Remove bumper and set aside for reinstallation.

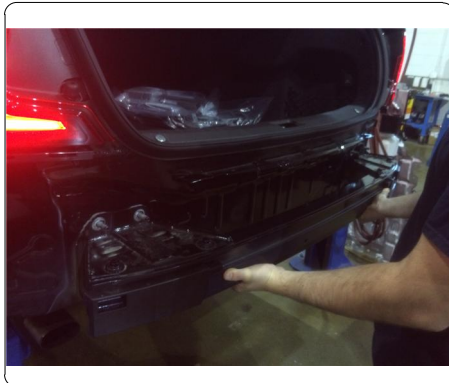
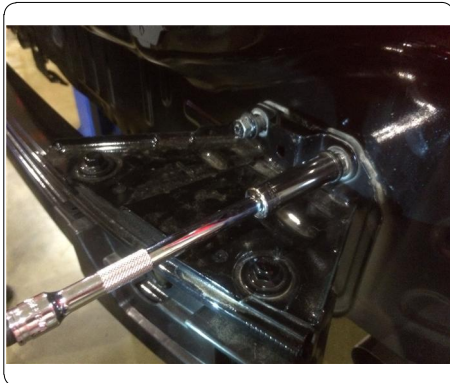

9. Install hitch on rear of vehicle frame using existing studs to align. Reinstall bumper beam over hitch. Loosely secure vehicle hardware.



10. Torque all M10 hardware to 45 ft-lbs. Reinstall trimmed rear fascia and trunk contents using steps 1-7 in reverse order.

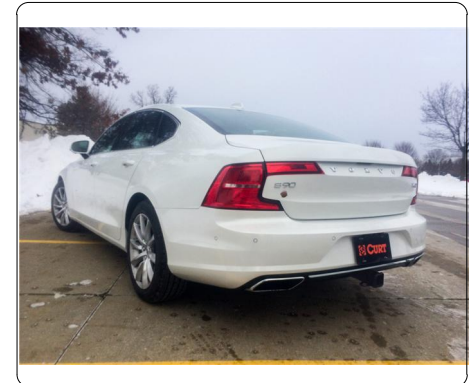

## TOWING SAFETY INFORMATION

### Gross Trailer Weight / GTW

The Gross Trailer Weight is the weight of the trailer & cargo. Measure this by putting the fully loaded trailer on a vehicle scale.



### Tongue Weight / TW

The downward force that is exerted on the hitch ball by the coupler. The tongue weight will vary depending on where the load is positioned in relationship to the trailer axle(s). To measure the tongue weight, use either a commercial scale or a bathroom scale with the coupler at towing height. When using a bathroom scale with heavier tongue weights, use the method shown and multiply the scale reading by 3.

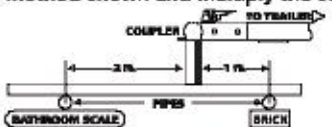

### Weight Carrying / WC

The total weight of both the trailer and the cargo inside. Never exceed the weight capacity of your trailer hitch.

### Weight Distribution / WD

Used to balance the weight of the cargo between the front and rear wheels throughout the trailer, allowing for better steering, braking, and level riding.



### Sway Control

A device used to reduce the lateral movements of the trailer that are caused by the wind. This works in conjunction with a weight distribution hitch. Do not use this on a class 1 or 2 hitch, or with surge brakes.

### How Much Can You Safely Tow?

TONGUE WEIGHT (lb.)	Tongue weight should be about 10 to 15 percent of the gross trailer weight.											
	1000	2000	3000	4000	5000	6000	7000	8000	10,000	12,000	14,000	16,000
TRAILER TYPE	CLASS 1											
	CLASS 2											
	CLASS 3											
	CLASS 4											
	CLASS 5											
Coupler	1 1/2"	1 3/4"	1 3/4"	1 3/4"	1 3/4"	1 3/4"	1 3/4"	1 3/4"	1 3/4"	1 3/4"	1 3/4"	1 3/4"
Trailer	1100	1200	1300	1400	1500	1600						
Weight	1 1/2"	1 3/4"	1 3/4"	1 3/4"	1 3/4"	1 3/4"	1 3/4"	1 3/4"	1 3/4"	1 3/4"	1 3/4"	1 3/4"
Trailer	2100	2400	2700	3000	3300	3600	3900	4200	4500	4800		
Weight	1 1/2"	1 3/4"	1 3/4"	1 3/4"	1 3/4"	1 3/4"	1 3/4"	1 3/4"	1 3/4"	1 3/4"	1 3/4"	1 3/4"
Trailer	2800	3200	3600	4000	4400	4800	5200	5600	6000	6400		
3-6 Wheel												

Refer to owner's manual for towing capabilities and limitations.

### Ball Mount

The ball mount is placed inside the opening of the receiver hitch which is mounted to the vehicle. Make sure a hitch pin and clip is properly securing the ball mount to the receiver hitch before you begin towing.

• A: Rise. B: Drop. C: Hole Size. D: Length.

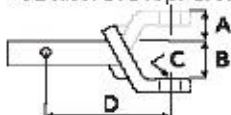

### Trailer Ball

The connection from the hitch to the trailer. There are many factors that determine the correct hitch ball:

- Number one is the hitch ball's gross trailer weight rating.
- The mounting platform must be at least 3/8" thick.
- The hole diameter must not be more than 1/16" larger than the threaded shank.
- Every time you tow, check the nut and lock washer to make sure they are fastened securely.

• A: Ball Dia. B: Shank Dia. C: Shank Length. D: Shank Rise.

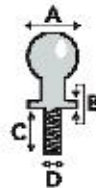

### Coupler

The component that is placed over the trailer ball to connect the vehicle to the trailer. Be sure that the coupler size matches the size of the hitch ball and that the coupler handle is securely fastened. To determine what size hitch ball you need for your application you will need to know the size of coupler that is on the trailer. Be sure your coupler is properly adjusted to the ball you are using.

NOTE: For added security the use of safety devices such as Coupler Safety Pins and Locks is strongly recommended.

### Safety Chains

Safety chains are a requirement and should be crossed under the tongue of the trailer so that the tongue will not drop to the road if it becomes separated from the hitch. Always leave enough slack so you can turn. Never allow the safety chains to drag on the ground and never attach the chains to the bumper.

Trailer Classification: Safety Chain Breaking Force - Minimum

Class 1: 2,000 lbs. (8.9 kN)

Class 2: 3,500 lbs. (15.6 kN)

Class 3: 5,000 lbs. (22.2 kN)

The strength rating of each length of safety chain or its equivalent and its attachments shall be equal to or exceed in minimum breaking force the GVWR (Gross Vehicle Weight Rating) of the trailer.

### Electrical

Trailer lights, Electric Brakes, Break-away systems - Every time you tow, be sure to check that all components are working properly.

Wiring identification by color:





**13305****VOLVO S90**

12/5/2016

GROSS LOAD CAPACITY WHEN USED AS A WEIGHT CARRYING HITCH: 5,000 LBS. TRAILER WEIGHT &amp; 500 LBS. TONGUE WEIGHT.

WARNING: ALL NON-TRAILER LOADS APPLIED TO THIS PRODUCT MUST BE SUPPORTED BY 18050 STABILIZING STRAPS.

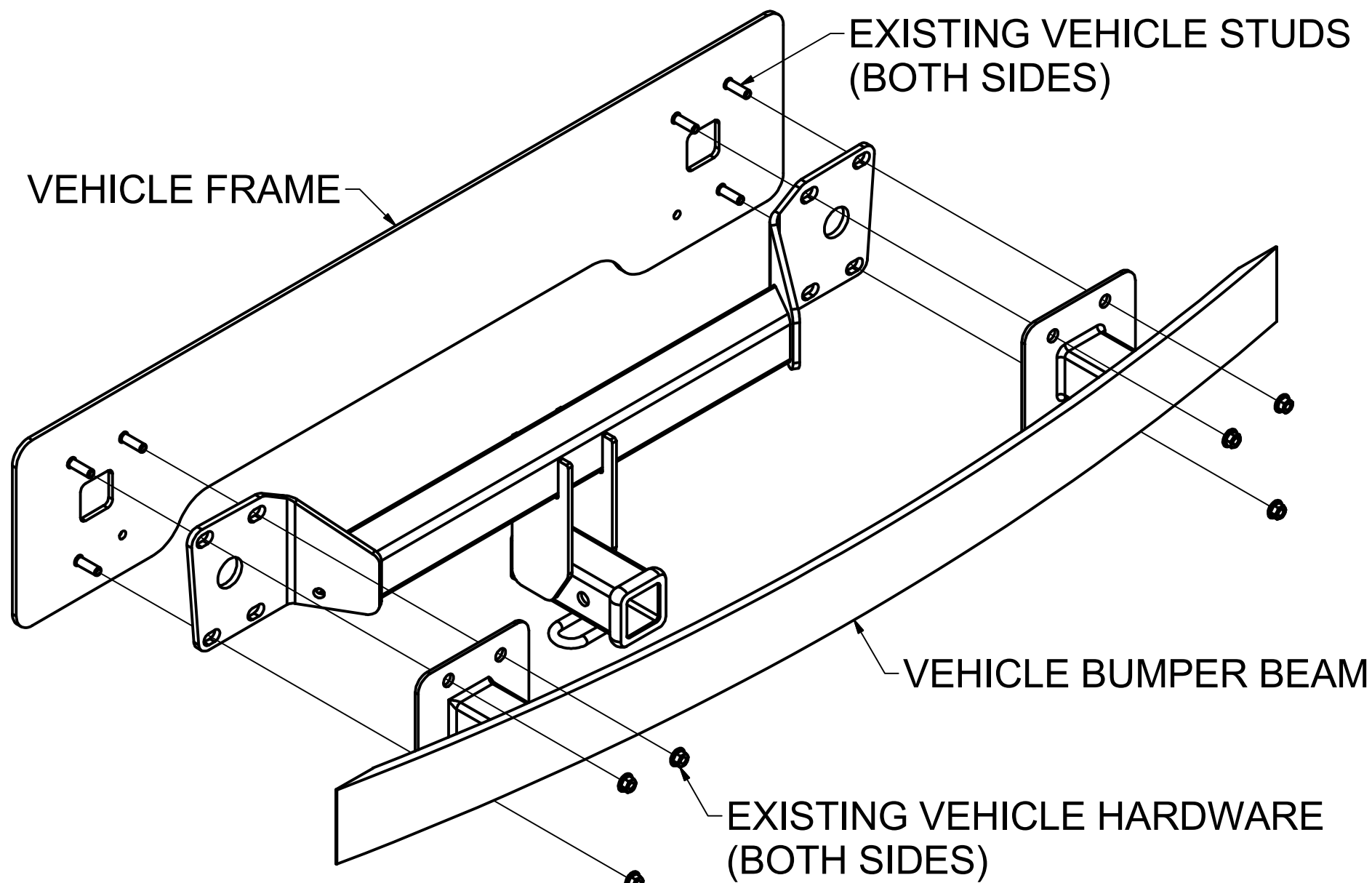
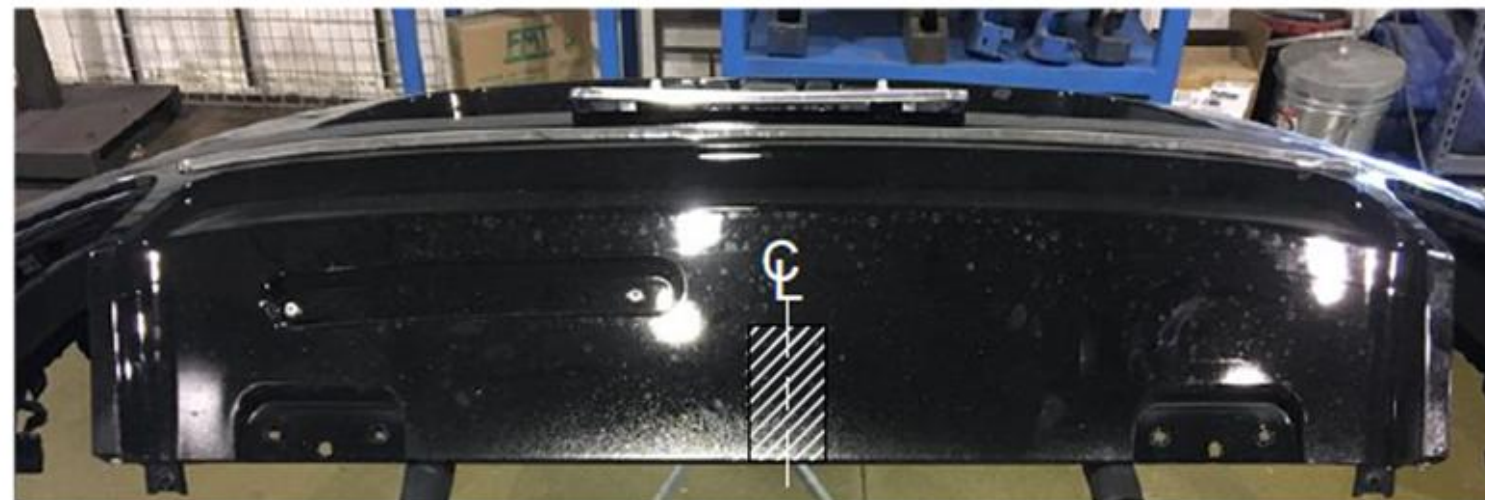
**WARNING: \*\* FAILURE TO PROPERLY SUPPORT NON-TRAILER LOADS WILL VOID PRODUCT WARRANTY \*\*****WARNING: \*\*\* DO NOT EXCEED VEHICLE MANUFACTURER'S RECOMMENDED TOWING CAPACITY \*\*\***FOR MORE INFORMATION LOG ONTO [WWW.CURTMFG.COM](http://WWW.CURTMFG.COM) & FOR HELPFUL TOWING TIPS LOG ONTO [WWW.HITCHINFO.COM](http://WWW.HITCHINFO.COM)  
HAVING INSTALLATION QUESTIONS? CALL TECHNICAL SUPPORT AT 1-800-798-0813**TRIM DIAGRAM**

**FRONT**  
↑  
**REAR**

HITCH WEIGHT: 30 LBS.

**INSTALL TIME**

PROFESSIONAL: 60 MINUTES

NOVICE (DIY): 120 MINUTES

**INSTALL NOTES:**

- TEMPORARILY REMOVE TRUNK CONTENTS AND REAR FASCIA
- NO DRILLING REQUIRED
- TRIM REAR FASCIA

**INSTALLATION STEPS**

1. Underneath rear of vehicle, locate and remove (4) screws attaching rear fascia to vehicle using T-25 socket.
2. Along rear wheel well on each side, locate and remove (5) screws using T-25 socket.
3. Pull wheel well cover back on each side of vehicle to expose (1) screw remove using T-25 socket.  
**NOTE:** Remove plastic clip with screw behind wheel well cover.
4. Inside trunk along trunk liner guard locate and remove (2) capped nuts using crescent wrench and (2) bolts using 10mm socket. Gently unclip trunk liner guard and set aside for reinstallation.
5. Remove trunk liner to expose and remove (5) plastic nuts using 10mm socket. Set aside for reinstallation.
6. On trunk wall gently unclip (1) plastic push pin, on each side, to expose (3) taillight nuts, on each side. Remove taillight nuts using 8mm socket and unclip electrical harness. Set aside hardware for reinstallation.
7. Gently unclip rear fascia and remove starting from outside and working your way towards center of vehicle. Unclip electrical harness. Trim 3.25" x 5.00" using aviation shears as shown in trim diagram. Set aside for reinstallation.
8. Locate on each side of bumper beam and remove (3) nuts using 15mm socket. Remove bumper and set aside for reinstallation.
9. Install hitch on rear of vehicle frame using existing studs to align. Reinstall bumper beam over hitch. Loosely secure vehicle hardware.
10. Torque all M10 hardware to 45 ft-lbs. Reinstall trimmed rear fascia using steps 1-7 in reverse order.

**PERIODICALLY CHECK THIS RECEIVER HITCH TO ENSURE THAT ALL FASTENERS ARE TIGHT AND THAT ALL STRUCTURAL COMPONENTS ARE SOUND.**



Scan for more information

CURT Manufacturing LLC., warrants this product to be free of defects in material and/or workmanship at the time of retail purchase by the original purchaser. If the product is found to be defective, CURT Manufacturing LLC., may repair or replace the product, at their option, when the product is returned, prepaid, with proof of purchase. Alteration to, misuse of, or improper installation of this product voids the warranty. CURT Manufacturing LLC.'s liability is limited to repair or replacement of products found to be defective, and specifically excludes liability for incidental or consequential loss or damage.

This product complies with safety specifications and requirements for connecting devices and towing systems of the state of New York, V.E.S.C.Regulation V-5 and SAE J684.