

# INSTALLATION INSTRUCTIONS

## ROCK CRAWLER ROOF RACK 07-UP JEEP WRANGLER J/K 4DOOR PART#: PW005021

### PARTS LIST:

1	Driver/Left Front Leg	(A)	2	2" Plastic caps for bottom of front legs
1	Passenger/Right Front Leg	(B)	6	Peel & Stick Foam Gaskets for Front Legs and Short Rear Mounting Brackets
1	Driver/Left Rear Top Leg	(C)	6	12mm Rubber Plug/Grommets
1	Passenger/Right Rear Top Leg	(D)	4	12-1.75mm x 35mm Hex Bolts
1	Driver/Left Rear Bottom Leg	(E)	4	12mm x 32mm OD x 3mm Flat Washers
1	Passenger/Right Rear Bottom Leg	(F)	4	12mm Lock Washers
2	Short Rear Mounting Bracket (optional drill mount)	(G)	4	10-1.50mm x 35mm Hex Bolts
2	Metal Backing Plates (optional drill mount)	(H)	4	10mm x 27mm OD x 3mm Flat Washers
8	Knobs with 8mm Nylon Locking Hex Nut	(I)	4	10mm Lock Washers
1	Front Cross Bar / Light Bar	(J)	8	8-1.25mm x 70mm Allen Bolts ( <b>for Cross Rail use only</b> )
1	Rear Cross Bar / Light Bar	(K)	14	8-1.25mm x 65mm Allen Bolts
1	Front Basket Holder Cross Rail (Short)	(L)	12	8-1.25 x 35mm Hex Bolts Gr. 10.9
1	Front-Center Basket Holder Cross Rail (Mid Length)	(L)	8	8mm x 24mm OD x 2mm Large Flat Washers
1	Rear-Center Basket Holder Cross Rail (Mid Length)	(L)	52	8mm x 16mm OD x 1.6mm STD Flat Washers
1	Rear Basket Holder Cross Rail (Long)	(L)	8	8mm Lock Washers
2	Side Rails	(M)	18	8mm Nylon Lock Nuts
2	12mm Double Nut Plates	(N)	2	ST # 5 x 30mm Sheetmetal Screw
2	Rubber Bumpers		2	ST 9.8mm OD x 5.4mm ID x 1.1mm Flat Washers

**CAUTION:** Recommended load rate is 350 lb. Excessive weight will greatly reduce the stability of your vehicle and increase the vehicle's tendency to overturn. The manufacturer makes no representation or warranty as to the amount of weight that your vehicle can safely carry. For guidance, we recommend that you consult the vehicle manufacturer. Secure all payloads properly for safe transportation. The Rock Crawler Roof Rack is NOT designed as a roll over roll bar.

**NOTE:** The "no drilling required, bolt-on" bottom rear leg mounts, (E & F), of your new Rock Crawler Roof Rack are designed to work with aftermarket bumpers only and are not compatible with the factory bumper.





(A)

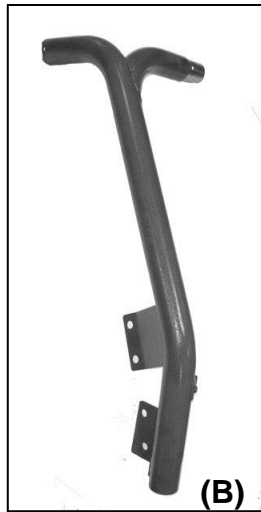

(B)

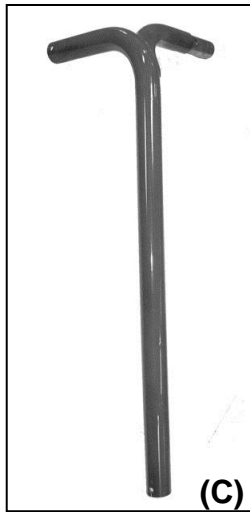

(C)

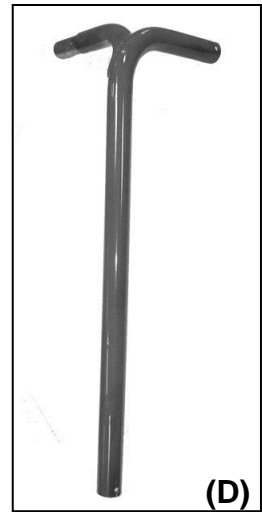

(D)



(E)



(F)

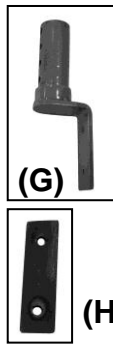

(G)



(H)

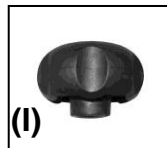

(I)

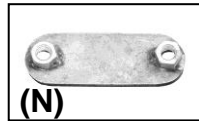

(N)

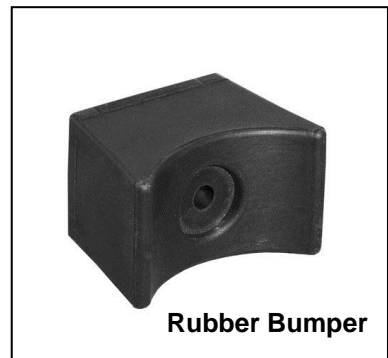

Rubber Bumper

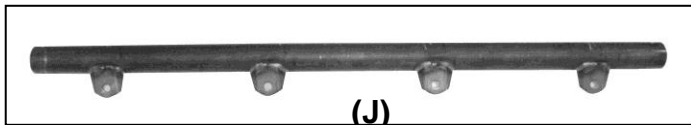

(J)

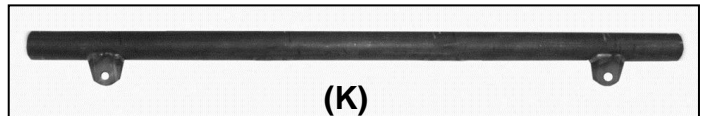

(K)



(L) 1 of 4 Cross Bar (Example)

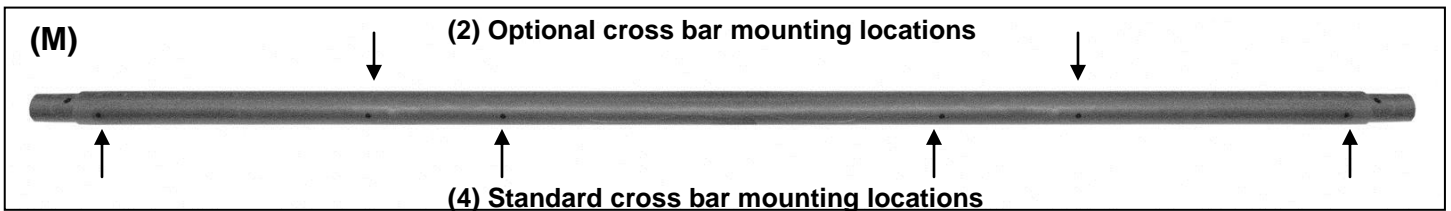

(M)

(2) Optional cross bar mounting locations

(4) Standard cross bar mounting locations

REMOVE CONTENTS FROM BOX. VERIFY ALL PARTS ARE PRESENT. READ INSTRUCTIONS CAREFULLY BEFORE STARTING INSTALLATION. DRILLING IS OPTIONAL.

DO NOT TIGHTEN ANY HARDWARE UNTIL THE ROOF RACK IS FULLY ASSEMBLED.

## DO NOT TIGHTEN HARDWARE UNTIL ASSEMBLY IS FINISHED

### PROCEDURE:

1. Peel, stick and trim the self sticking Foam Gaskets to the inside surface of the two mounting tabs on each Front Leg. Remove the driver side (4) factory outer windshield hinge bolts. Locate the driver side Front Leg, **(A)** and attach it to the windshield hinge using (4) 8-1.25mm x 35mm Hex Bolts, (4) 8mm Lock Washers and (4) 8mm x 24mm OD x 2mm Large Flat Washers, **(Figure 1)**.

Apply foam tape to the back of these mounting tabs to protect vehicle's finish.

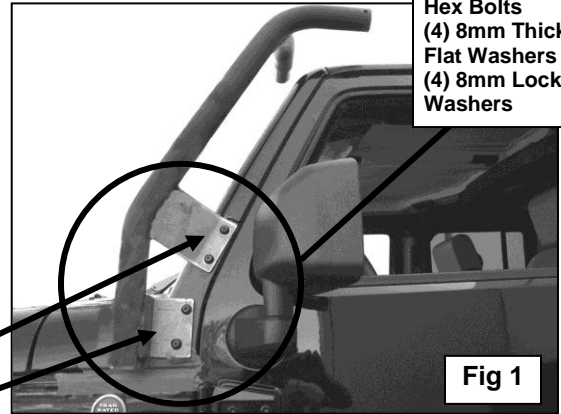

2. Slide front Cross Bar, **(J)** into partially installed driver side Front Leg and secure it with the included (1) 8mm x 65mm Allen Bolt, (2) 8mm Flat Washers and (1) 8mm Nylon Lock Nut, **(Figure 2)**.

Cross Bar pictured with tabs facing forward (optional). Recommended install is with tabs facing to the rear.

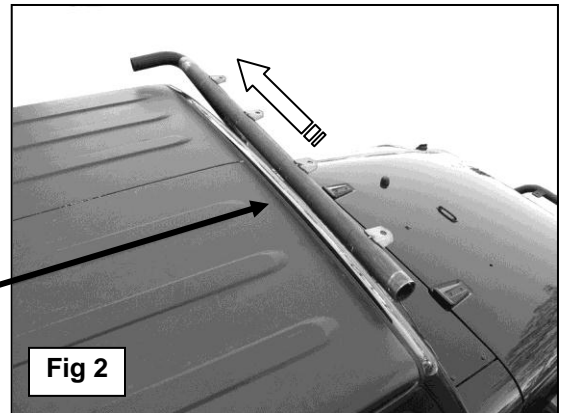

3. Remove the passenger side (4) factory outer windshield hinge bolts. Locate the passenger side Front Leg, **(B)** and apply the Foam Gasket as described in Step 1. Align the holes on the lower section of the Front Leg with holes on the windshield hinge and slide the tube into the Cross Bar. Secure the Front Leg to the vehicle using (4) 8-1.25mm x 35mm Hex Bolts, (4) 8mm Lock Washers and (4) 8mm x 24mm OD x 2mm Thick Flat Washers. Proceed to secure upper section of the Front Leg to Front Cross Bar using the included (1) 8mm x 65mm Allen Bolt, (2) 8mm Flat Washers and (1) 8mm Nylon Lock Nut, **(Figure 3)**.



4. Remove the two bolts holding the aftermarket bumper-if equipped, **(Figure 4)**.

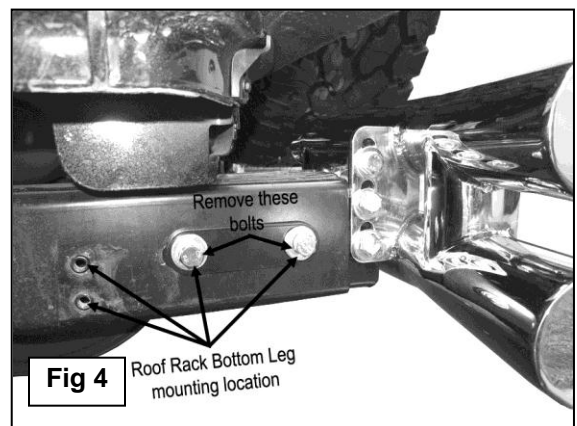

**DO NOT TIGHTEN HARDWARE UNTIL ASSEMBLY IS FINISHED**

5. **OPTIONAL:** If you decide to bolt the Roof Rack directly to the body of the vehicle, remove both taillights from vehicle at this time, **(Figure 5)**. **NOTE: Drilling required for "Bolt Direct to Body" Installation. See Figures 14-On, Steps 18-On for detailed information.**

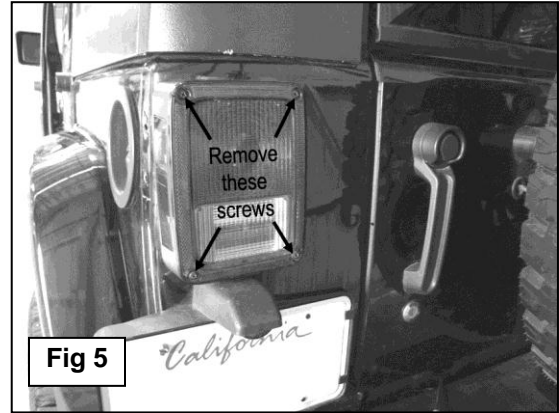

6. **NOTE:** Cover the ends of the Side Rails, **(M)** facing the rear of the vehicle with masking tape to protect the vehicle from damage during assembly. Slide both Side Rails, (with top holes angled towards the outside of the vehicle), into the previously installed Front Legs. Secure the Side Rails to the Front Legs using the included (1) 8mm x 65mm Allen Bolt, (2) 8mm Flat Washers and (1) 8mm Nylon Lock Nut, **(Figure 6)**. Do not tighten hardware.

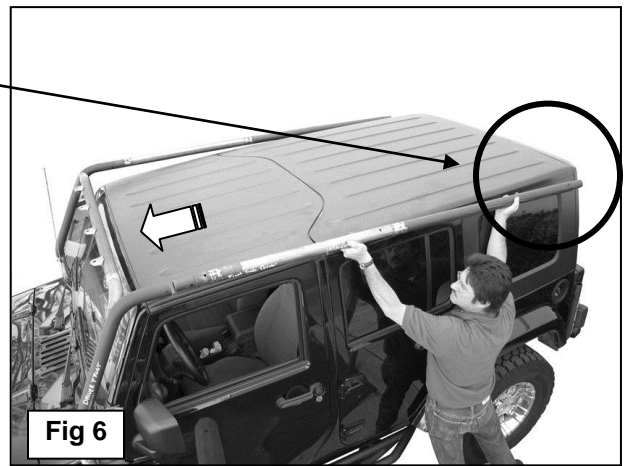

7. To better support the Roof Rack when loaded, (2) Rubber Bumpers are included in the installation kit. The Rubber Bumpers can be installed at a point 29" up from the end of the Rear Leg for vehicles with hard tops or at 6-3/8" for vehicles with hard or soft tops, **(Figure 7)**. Once the location is determined and marked, select the side of the Rear Leg, **(C, D)** facing the vehicle and mark the location. Remove the Rear Leg. Place the Rear Leg on a stable work surface with the side to be drilled facing up. Drill an 1/8" hole into the Rear Leg. Drill only through the side requiring the Rubber Bumper. Do not drill through both sides of the tube. Secure the Rubber Bumper to the Rear Leg with (1) #5 x 30mm Screw and (1) 5mm Flat Washer. Snug but do not over tighten or the Rubber Bumper will be deformed.

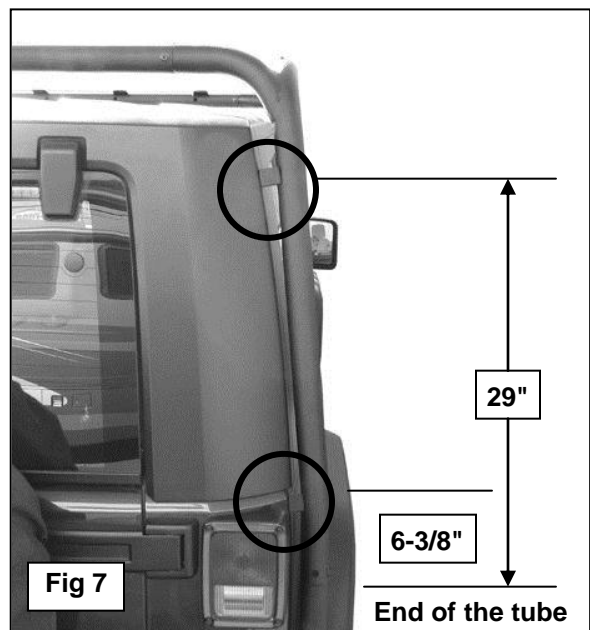

## DO NOT TIGHTEN HARDWARE UNTIL ASSEMBLY IS FINISHED

8. On a clean, stable work area, assemble the rear section of the Roof Rack by attaching both Upper Rear Legs, **(C & D)** to the Rear Cross Bar, **(K)**. **NOTE:** The Rear Cross Bar can be installed with the light tabs facing forward (preferred) or rearward (optional). Secure this assembly by using the included (2) 8mm x 65mm Allen Bolts, (4) 8mm Flat Washers and (2) 8mm Nylon Lock Nuts, **(Figure 8)**. Do not tighten hardware at this time.

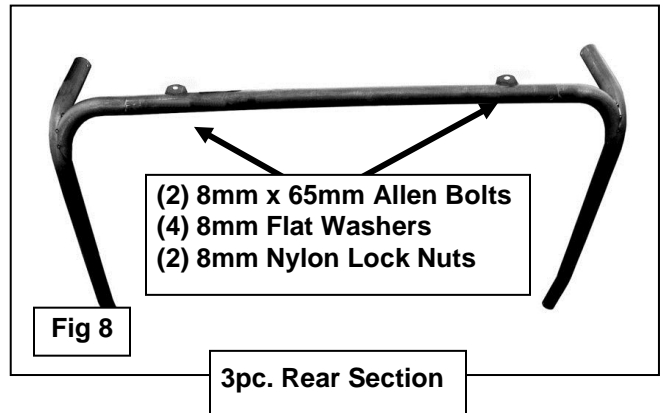

With assistance, attach the assembled rear top section of the Roof Rack to the already inserted Side Rails. **NOTE:** Be careful not to damage the vehicle when attaching the top section. Use the included (2) 8mm x 65mm Allen Bolts, (4) 8mm Flat Washers and (2) 8mm Nylon Lock Nuts to attach the Rear Top Legs to the Side Rails, **(Figure 9 & 10)**.

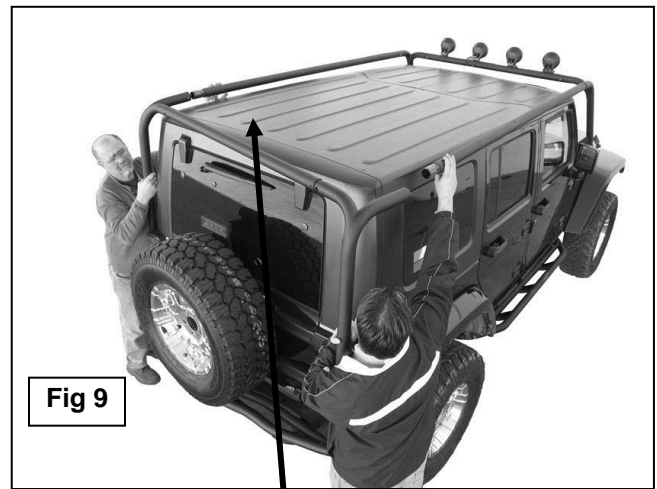

**IMPORTANT! Do not lay Roof Rack on your vehicle to attach the Rear Bottom Legs at any time. Damage to the vehicle may occur.**

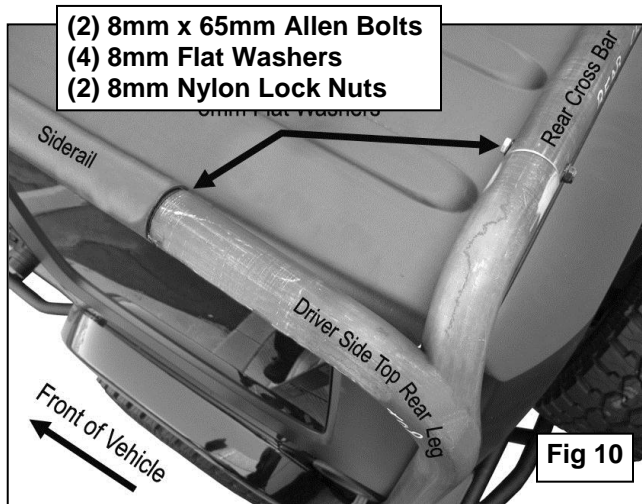

9. For "Bolt Direct to Body" installation, proceed to Step 18.
10. With assistance, hold the rear section of the Roof Rack up and attach the Rear Bottom Leg section, **(E & F)** to the Rear Top Leg section using the included (2) 8mm x 65mm Allen Bolts, (4) 8mm Flat Washers and (2) 8mm Nylon Lock Nuts, **(Figure 11)**. **IMPORTANT!** Do not lay Roof Rack on your vehicle to attach the Rear

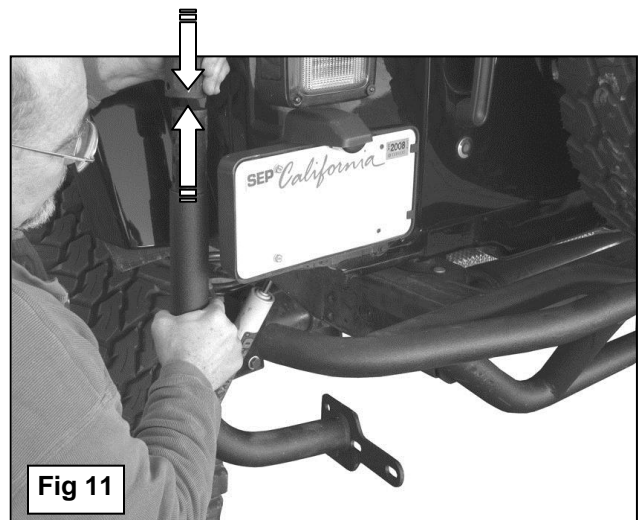

Bottom Legs at any time. Damage to the vehicle may occur.

## DO NOT TIGHTEN HARDWARE UNTIL ASSEMBLY IS FINISHED

Position the passenger Rear Bottom Leg, **(F)** up to the frame and align the holes in the Bracket with holes in the frame for the bumper. Secure the rear holes in the Mounting Bracket to the bumper using the same bolts that came with your aftermarket bumper. Attach the front of the Bracket to the frame using the factory bolts or the included hardware, **(Figure 12A & 11B)**. Repeat this Step for the driver side installation.

**Note:** Installation shown with aftermarket bumper. Use the included Double Nut Plate, **(N)**, inside the rectangular frame tube as required for installation on vehicles without rear bumper or aftermarket bumpers that are not threaded for mounting bolts. Also use the following hardware included with this kit as needed:

- (4) 12-1.75mm x 35mm Hex Bolts
- (4) 12mm Lock Washers
- (4) 12mm x 32mm OD x 3mm Flat Washers

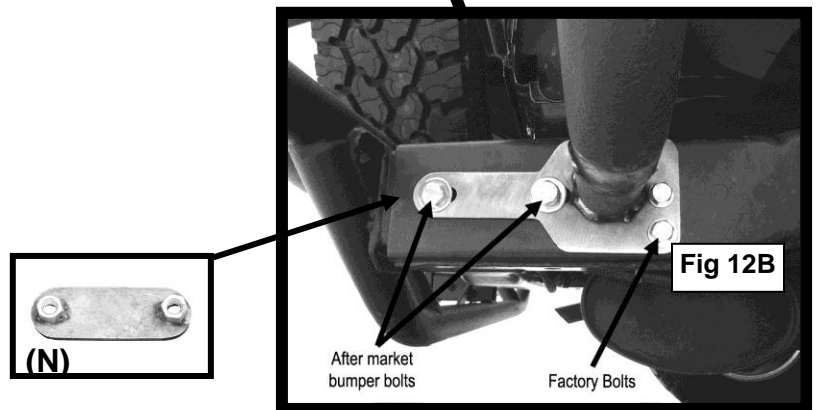
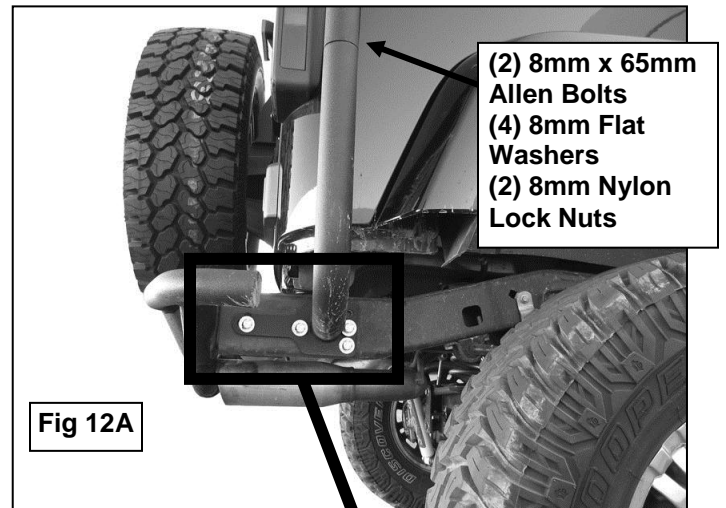

**11. IMPORTANT:** All Basket Holder Cross Rails, **(L)** are different sizes with the shortest to the front, mid length to the center and the longest to the rear of the Roof Rack. Locate the shortest Cross Rail and position it over the mounting holes toward the front of vehicle, **(Figure 13)**.

**12.** To secure the Basket Holder Cross Rail to Side Rails, insert (1) 8mm x 70mm Allen Bolt with (1) 8mm Flat Washer up through the bottom hole in the Side Rail and through Cross Rail. Place (1) 8mm Flat Washer over the bolt and secure it with the included Plastic Knob, **(Figure 13)**.

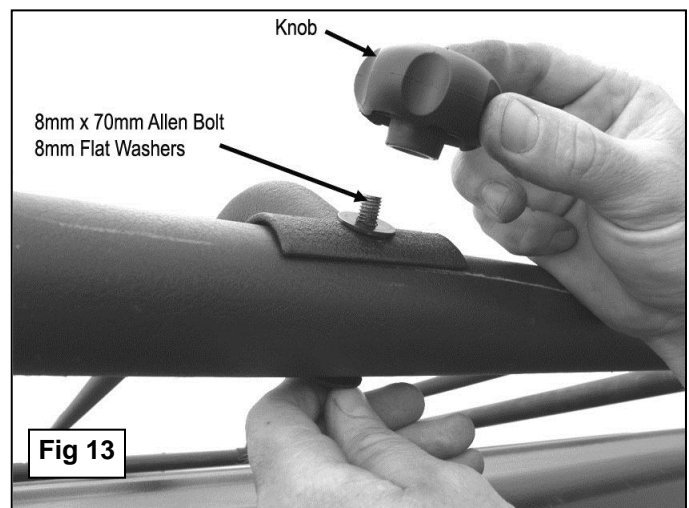

**NOTE:** There are additional holes in each top side rail to allow front to back adjustment of cross bar locations for different basket or Roof Rack accessories, (see Page 3). Install bars in desired locations to properly support accessories. Extra 8mm x 65mm hardware has been provided to fill unused cross bar holes.

**13.** Repeat Steps 12 - 13 for the rest of the Basket Holder Cross Rails.

**14.** Align Roof Rack properly then **tighten all hardware**.

**15.** Do periodic inspections to the installation to make sure all hardware is secure and tight.

## OPTIONAL "BOLT DIRECT TO BODY" INSTALLATION INSTRUCTIONS

16. Select the (2) Short Bottom Brackets and apply Peel and Stick Foam Gasket Material (G) to the back of the 2-hole mounting tabs. With assistance, hold the rear section of the Roof Rack up and attach the Short Bottom Bracket to the Rear Top Leg Section using the included (2) 8mm x 65mm Allen Bolts, (4) 8mm Flat Washers and (2) 8mm Nylon Lock Nuts (**Figure 14**).

**IMPORTANT!** Do not lay Roof Rack on your vehicle to attach the Rear Bottom Legs at any time. Damage to the vehicle may occur.

**WARNING:** Before drilling into the vehicle, verify that all parts of the Roof Rack are completely clear of any top mechanisms, (soft and hard tops), sunroofs and factory or added accessories

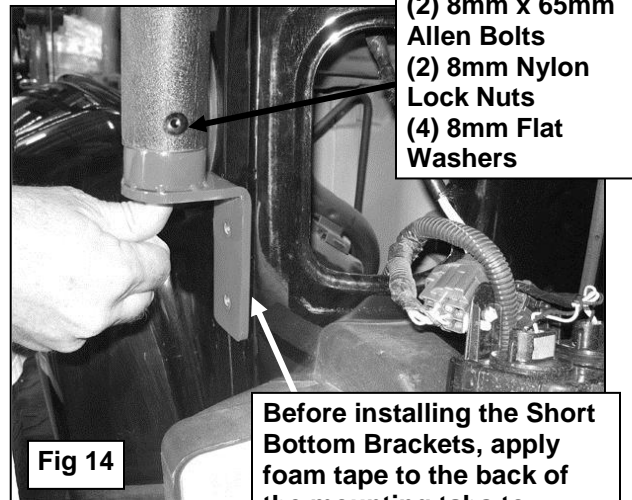

Fig 14

Before installing the Short Bottom Brackets, apply foam tape to the back of the mounting tabs to protect vehicle's finish

17. Align the Side Rails parallel with the roof of the vehicle, and then use the holes in the Short Bottom Bracket as a template to mark the drilling location on the vehicle, (**Figure 15**). **NOTE:** Center of the holes must be 3/4" from body seam, (**Figure 16**).

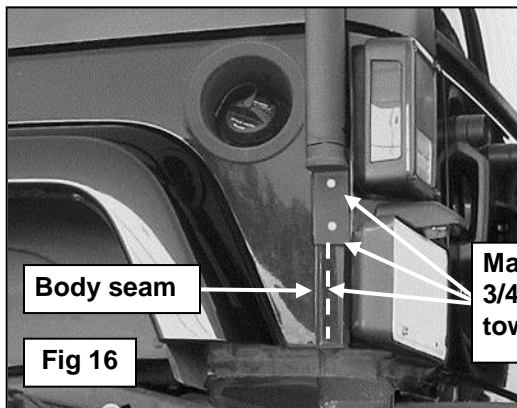

Fig 16

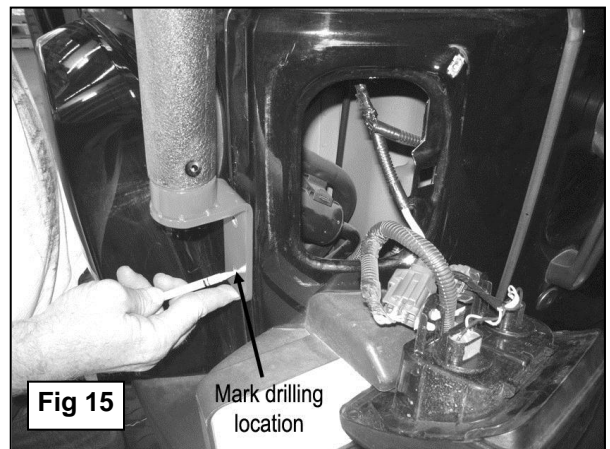

Fig 15

18. Once you have marked the drill locations on both sides of the vehicle, remove the rear assembly of the Roof Rack and set it aside. **NOTE:** Do not remove the Short Bottom Brackets from the Rear Legs.

19. Use a 3/8" drill bit to drill out the (4) marked locations, (**Figure 17**). **IMPORTANT:** Any cutting or drilling tool may break or shatter. Government regulations require safety glasses & equipment at all times when cutting or drilling.

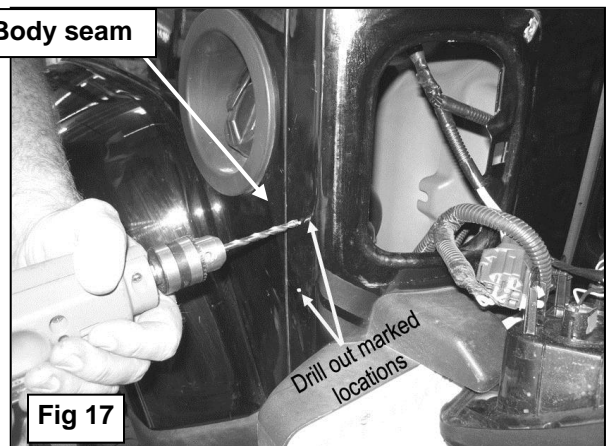
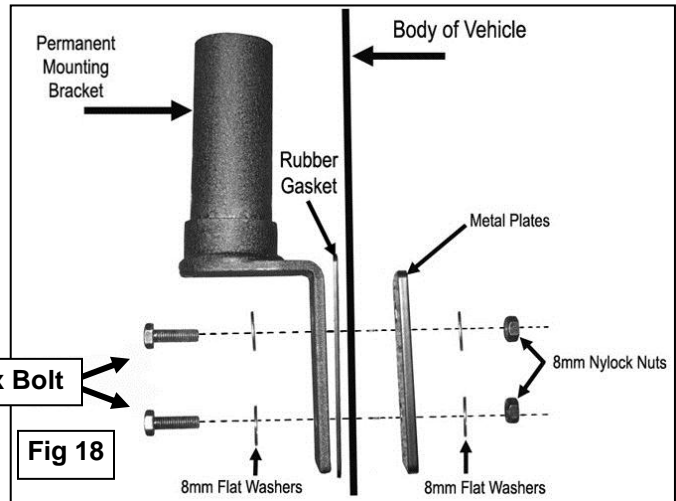

Fig 17



20. Starting on the driver side, place adhesive backed rubber gaskets between the body and the Short Bottom Brackets, **(Figure 18)**.
21. With assistance, re-install the rear assembly of the Roof Rack to the Side Rails. Line up the holes in the Bottom Bracket to previously drilled holes, **(Figure 18)**.

8mm x 35mm Hex Bolt



22. Insert (2) 8mm x 35mm Hex Head Bolts with (2) 8mm Flat Washers through the Short Bottom Brackets and body. Access the hardware through the opening for the taillight and position the 2-hole Metal Plates over the already inserted 8mm Hex Bolts, **(Figure 19)**.

(2) 8mm x 35mm Hex Bolts  
(4) 8mm Flat Washers  
(2) 8mm Nylon Lock nuts

23. Secure the Metal Plates using the included (2) 8mm Flat Washers and (2) 8mm Nylon Lock Nuts, **(Figure 19)**.

24. Repeat Steps 21 - 25 for the passenger side installation.

25. Go to Steps 13 - 14 to attach the Basket Holder Cross Rails.

26. Align Roof Rack properly and **tighten all hardware**.

27. **IMPORTANT:** Do periodic inspections to the installation to make sure all hardware is secure and tight.

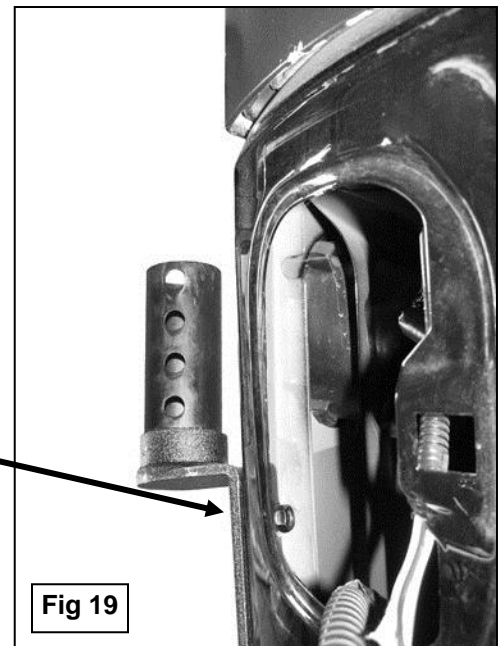

**To protect your investment**, wax this product after installing. Regular waxing is recommended to add a protective layer over the finish. Do not use any type of polish or wax that may contain abrasives that could damage the finish.