

GENERAL VIEW

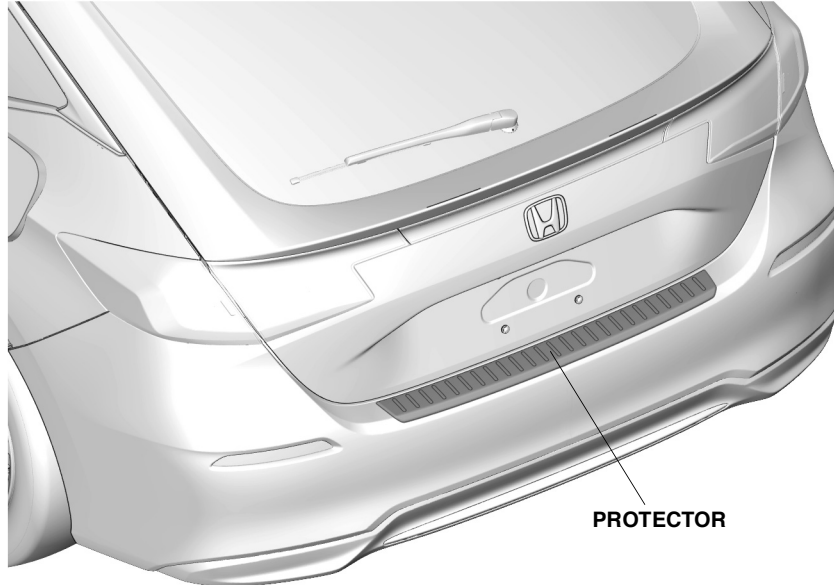

QL11601AH

FOR YOUR SAFETY (Read carefully.)

Warning Symbols

Safety: Your safety, and the safety of others, is important. To help you make informed decisions about service procedures, we have provided safety messages where appropriate. Of course, it is not practical or possible to warn you about all the hazards associated with servicing a vehicle - you must use your own good judgment.

You will find important safety messages preceded by one of following symbols:

*All symbols are not used in all installation instructions.

⚠ DANGER

You will be killed or seriously hurt if you do not follow the instructions.

⚠ WARNING

You can be killed or seriously hurt if you do not follow the instructions.

⚠ CAUTION

You can be hurt if you do not follow the instructions.

NOTICE

Gives advice to prevent damage to the product, vehicle, the environment or other property.

NOTE

Gives helpful information or instructions to be followed when installing this product.



Indicates a prohibited action.

Procedure and Location Icons

These icons indicate the work location and the worker's point of view.

*All icons are not used in all installation instructions.

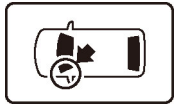

The location on the vehicle.

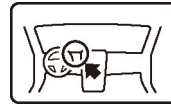

The location in the vehicle.
(instrument panel.)



Wear eye protection.



Wear heavy gloves.



Use an assistant.



Place the part on a blanket.



Work perpendicular.



Remove any burrs.



Use touch-up paint and allow to dry.



Tighten to the specified torque.



Apply firm pressure while rolling, especially at the ends, to set the adhesive.



Press firmly.



Clean with isopropyl alcohol.



Return the original part to the customer.
(Do not reuse.)

Safety: General

- Be careful not to damage the vehicle or the parts.
- The illustrations may differ slightly from the actual accessory.

Safety: Accessory

- Always use the parts and tools specified in the installation instructions.
- Do not install the accessory on a dirty surface or in direct sunlight.
- Make sure the ambient air temperature is 60°F (15°C) or above when installing accessories that use adhesive material.
- When pressing the accessory firmly with the palm of your hand, be careful not to damage it or the vehicle.
- When applying adhesive material, make sure it is lined up properly before attaching. Once the adhesive material touches the surface, do not try to remove it. If you do, you could damage the part.
- Do not wash the vehicle for 24 hours to allow the adhesive to cure.

PARTS LIST

Rear Bumper Protector Kit (P/N 08P01-T47-100)

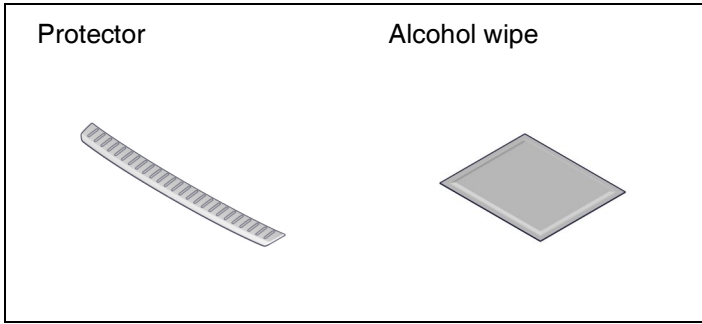

REQUIRED TOOLS AND SUPPLIES

- Masking tape
- Felt-tip pen

The following tool is available through the Honda Tool and Equipment Program:
Rubber Roller (T/N MHLE54D)

INSTALLATION

1. Attach the masking tape.

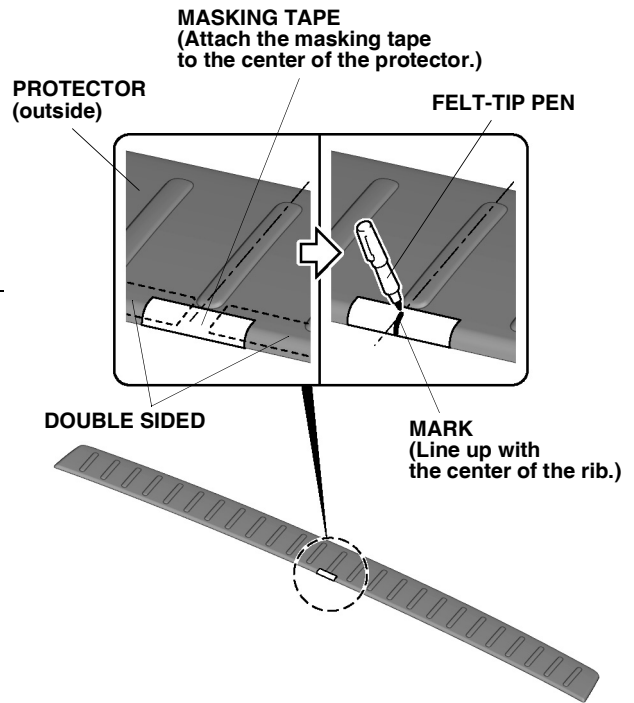

QL11602EH

2. Mark the masking tape.
3. Attach the masking tape.

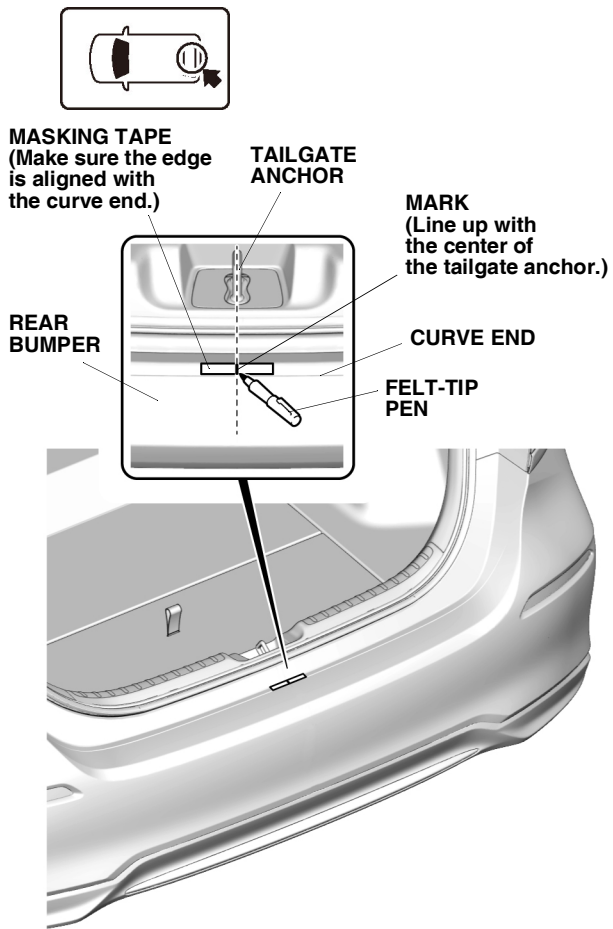

QL11604AH

4. Mark the masking tape.
5. Line up the protector.

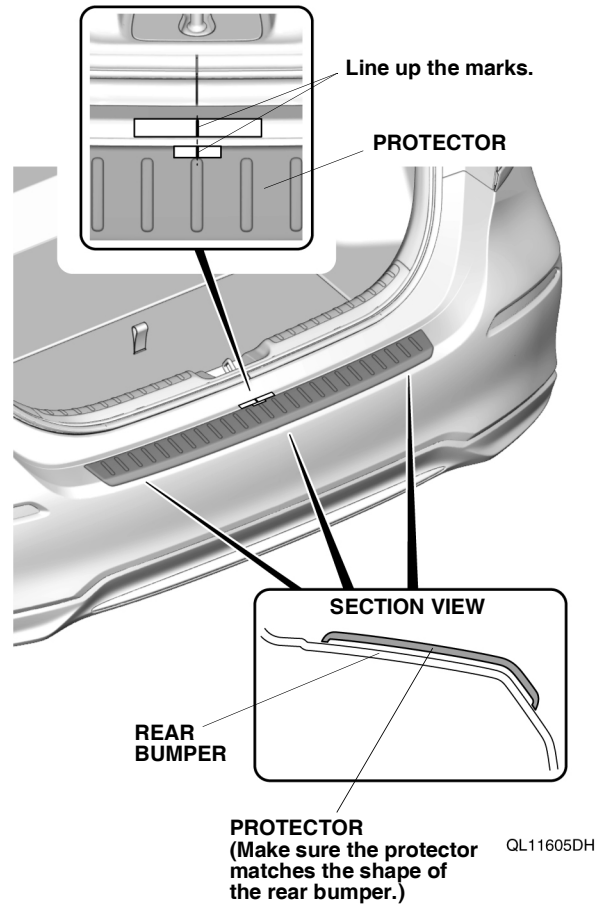

6. Attach the masking tape.

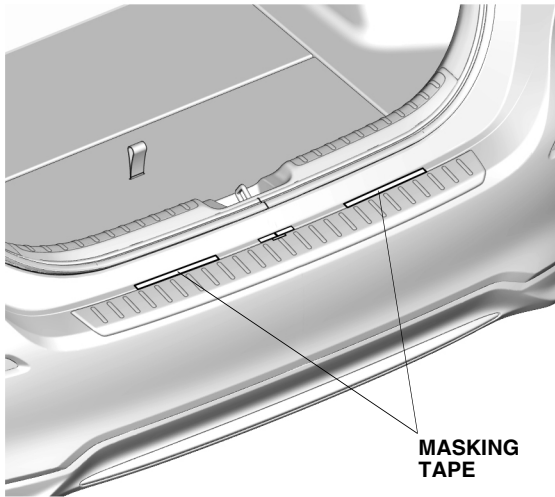

QL11606DH

7. Remove the protector.
8. Clean the attaching area.

NOTE

Allow to dry thoroughly.

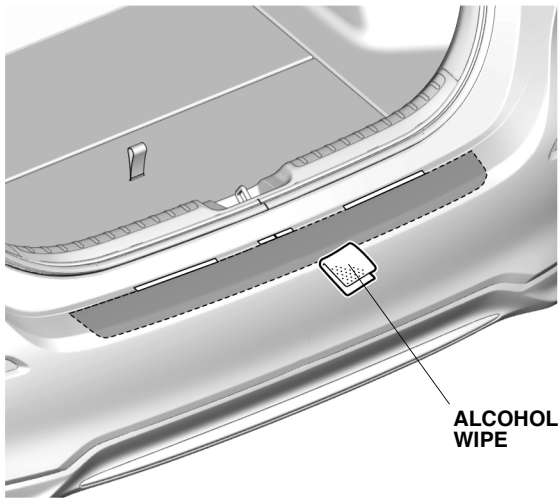

QL11607CH

9. Temporarily attach the adhesive backings.

4 ADHESIVE BACKINGS (Attach.)

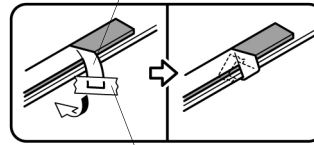

MASKING TAPE

2 ADHESIVE BACKINGS (Remove.)

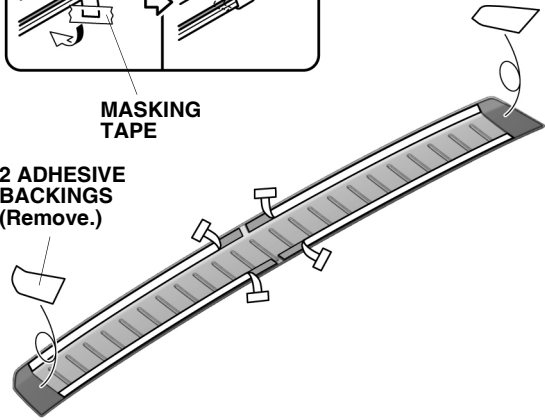

QL11608AH

10. Remove the adhesive backings.
11. Line up the protector.

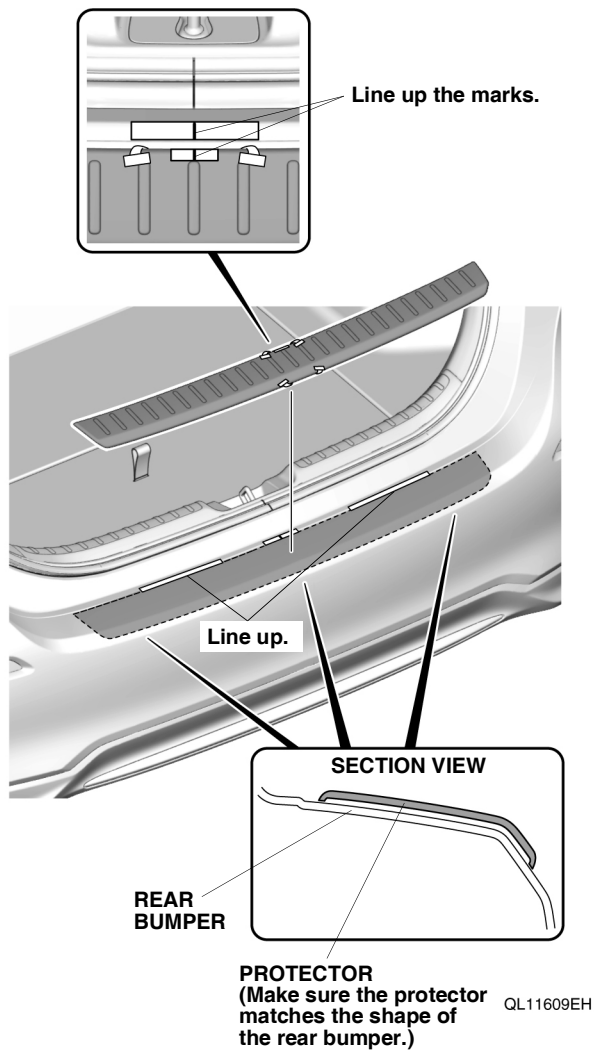

12. Secure the protector.

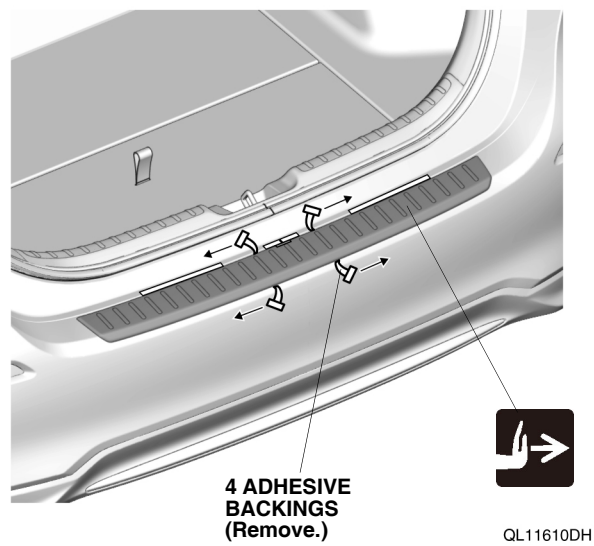

13. Set the adhesive.

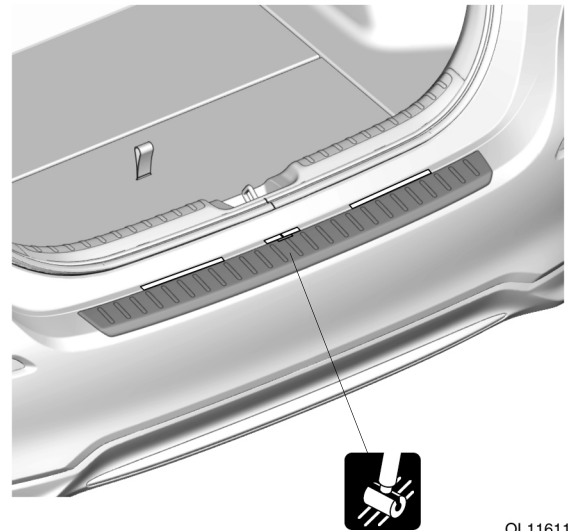

- 14. Remove the masking tape.
- 15. Check that all parts are installed properly.